



Transmitter Power Supply KFD2-CRG2-Ex1.D

- 1-channel isolated barrier
- 24 V DC supply (Power Rail)
- Input 2-wire and 3-wire transmitters and 2-wire current sources
- Output 0/4 mA ... 20 mA
- 2 relay contact outputs
- Adjustable energized/de-energized delay
- Programmable high/low alarm
- Linearization function (max 20 points)
- Line fault detection (LFD)
- Up to SIL 2 acc. to IEC 61508/IEC 61511



Function

This isolated barrier is used for intrinsic safety applications.

The device supplies 2-wire and 3-wire transmitters, and can also be used with current sources.

Two relays and an active 0/4 mA ... 20 mA current source are available as outputs. The relay contacts and the current output can be integrated in security-relevant circuits. The current output is easily scaled.

On the display the measured value can be indicated in various physical units.

The device is easily configured by the use of keypad or with the PACTware configuration software.

The input has a line fault detection.

A fault is signaled by LEDs acc. to NAMUR NE44 and a separate collective error message output.

For additional information, refer to the manual and www.pepperl-fuchs.com.

Connection

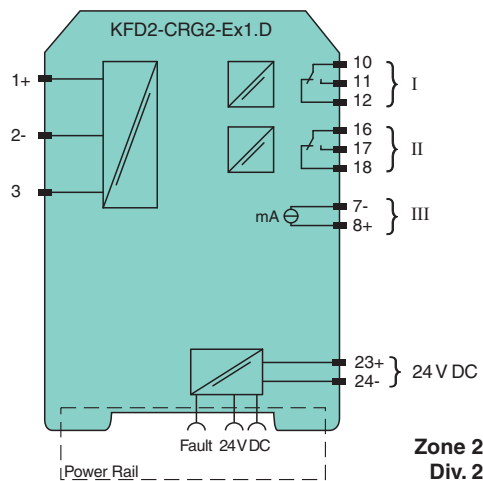
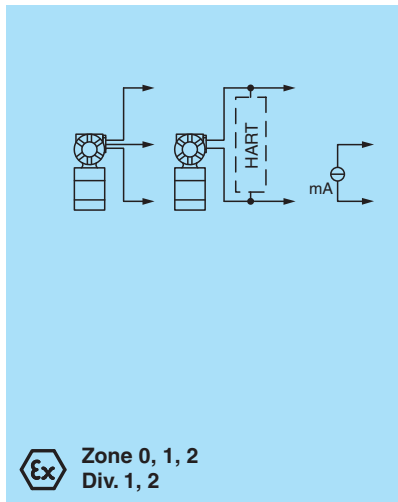

Technical Data

General specifications

Signal type Analog input

Functional safety related parameters

Safety Integrity Level (SIL) SIL 2

Supply

Connection Power Rail or terminals 23+, 24-

Rated voltage U_r 20 ... 30 V DC

Rated current I_r approx. 130 mA

Technical Data

Power dissipation	2 W
Power consumption	2.5 W
Interface	
Programming interface	programming socket
Input	
Connection side	field side
Connection	terminals 1, 2, 3
Input I	
Input signal	0/4 ... 20 mA
Available voltage	≥ 15 V at 20 mA
Open circuit voltage/short-circuit current	24 V / 33 mA
Input resistance	45 Ω (terminals 2, 3)
Line fault detection	breakage I < 0.2 mA; short-circuit I > 22 mA
Output	
Connection side	control side
Connection	output I: terminals 10, 11, 12 output II: terminals 16, 17, 18 output III: terminals 8+, 7-
Output signal	0 ... 20 mA or 4 ... 20 mA
Output I, II	
Contact loading	253 V AC / 2 A / $\cos \phi \geq 0.7$; 40 V DC / 2 A
Mechanical life	5 x 10 ⁷ switching cycles
Output III	
Current range	0 ... 20 mA or 4 ... 20 mA
Open loop voltage	max. 24 V DC
Load	max. 650 Ω
Fault signal	downscale I ≤ 3.6 mA, upscale I ≥ 21 mA (acc. NAMUR NE43)
Energized/De-energized delay	0 ... 250 s , adjustable
Transfer characteristics	
Input I	
Accuracy	< 30 μA
Influence of ambient temperature	0.003 %/K (30 ppm)
Output I, II	
Response delay	≤ 200 ms at bounce from 0 ... 20 mA
Output III	
Resolution	≤ 10 μA
Accuracy	< 20 μA
Influence of ambient temperature	0.005 %/K (50 ppm)
Reaction time	< 650 ms at bounce from 0 ... 20 mA at the input, 90 % of output full-scale value
Galvanic isolation	
Input/Other circuits	reinforced insulation according to IEC/EN 61010-1, rated insulation voltage 300 V _{eff}
Output I, II/other circuits	reinforced insulation according to IEC/EN 61010-1, rated insulation voltage 300 V _{eff}
Mutual output I, II, III	reinforced insulation according to IEC/EN 61010-1, rated insulation voltage 300 V _{eff}
Output III/power supply and collective error	functional insulation acc. to IEC 62103, rated insulation voltage 50 V _{eff}
Interface/power supply and collective error	functional insulation acc. to IEC 62103, rated insulation voltage 50 V _{eff}
Indicators/settings	
Display elements	LEDs , display
Control elements	Control panel
Configuration	via operating buttons via PACTware
Labeling	space for labeling at the front
Directive conformity	
Electromagnetic compatibility	
Directive 2014/30/EU	EN 61326-1:2013 (industrial locations)

Release date: 2022-02-24 Date of issue: 2022-02-24 Filename: 255620_eng.pdf

Technical Data

Low voltage			
Directive 2014/35/EU			EN 61010-1:2010
Conformity			
Electromagnetic compatibility			NE 21:2006
Degree of protection			IEC 60529:2001
Ambient conditions			
Ambient temperature			-20 ... 60 °C (-4 ... 140 °F)
Mechanical specifications			
Degree of protection			IP20
Connection			screw terminals
Mass			300 g
Dimensions			40 x 119 x 115 mm (1.6 x 4.7 x 4.5 inch) (W x H x D) , housing type C2
Mounting			on 35 mm DIN mounting rail acc. to EN 60715:2001
Data for application in connection with hazardous areas			
EU-type examination certificate			TÜV 01 ATEX 1701
Marking			Ⓜ II (1)G [Ex ia Ga] IIC Ⓜ II (1)D [Ex ia Da] IIIC Ⓜ I (M1) [Ex ia Ma] I
Input			Ex ia
Supply			
Maximum safe voltage	U _m		40 V DC (Attention! The rated voltage can be lower.)
Equipment			terminals 1+, 3-
Voltage	U _o		25.8 V
Current	I _o		93 mA
Power	P _o		0.603 W
Equipment			terminals 2-, 3
Voltage	U _i		< 30 V
Current	I _i		115 mA
Voltage	U _o		5 V
Current	I _o		0.3 mA
Power	P _o		0.3 mW
Equipment			terminals 1+, 2 / 3-
Voltage	U _o		25.8 V
Current	I _o		112 mA
Power	P _o		720 mW
Output I, II			terminals 10, 11, 12; 16, 17, 18 non-intrinsically safe
Maximum safe voltage	U _m		253 V AC / 40 V DC (Attention! U _m is no rated voltage.)
Contact loading			253 V AC/2 A/cos φ > 0.7; 40 V DC/2 A resistive load
Output III			terminals 8+, 7- non-intrinsically safe
Maximum safe voltage U _m	U _m		40 V (Attention! The rated voltage can be lower.)
Interface			RS 232
Maximum safe voltage	U _m		40 V (Attention! The rated voltage can be lower.) , RS 232
Certificate			TÜV 02 ATEX 1885 X
Marking			Ⓜ II 3G Ex nA nC IIC T4
Output I, II			
Contact loading			50 V AC/2 A/cos φ > 0.7; 40 V DC/2 A resistive load
Galvanic isolation			
Input/Other circuits			safe electrical isolation acc. to IEC/EN 60079-11, voltage peak value 375 V
Directive conformity			
Directive 2014/34/EU			EN 60079-0:2012+A11:2013 , EN 60079-11:2012 , EN 60079-15:2010
International approvals			
FM approval			
Control drawing			16-554FM-12 (cFMus)

Release date: 2022-02-24 Date of issue: 2022-02-24 Filename: 255620_eng.pdf

Refer to "General Notes Relating to Pepperl+Fuchs Product Information".

Pepperl+Fuchs Group
www.pepperl-fuchs.comUSA: +1 330 486 0002
pa-info@us.pepperl-fuchs.comGermany: +49 621 776 2222
pa-info@de.pepperl-fuchs.comSingapore: +65 6779 9091
pa-info@sg.pepperl-fuchs.com

PEPPERL+FUCHS

Technical Data

UL approval	E223772
IECEX approval	
IECEX certificate	IECEX TUN 09.0007 IECEX TSA 18.0007X
IECEX marking	[Ex ia Ga] IIC, [Ex ia Da] IIIC, [Ex ia Ma] I Ex ec nC IIC T4 Gc
General information	
Supplementary information	Observe the certificates, declarations of conformity, instruction manuals, and manuals where applicable. For information see www.pepperl-fuchs.com .

Assembly

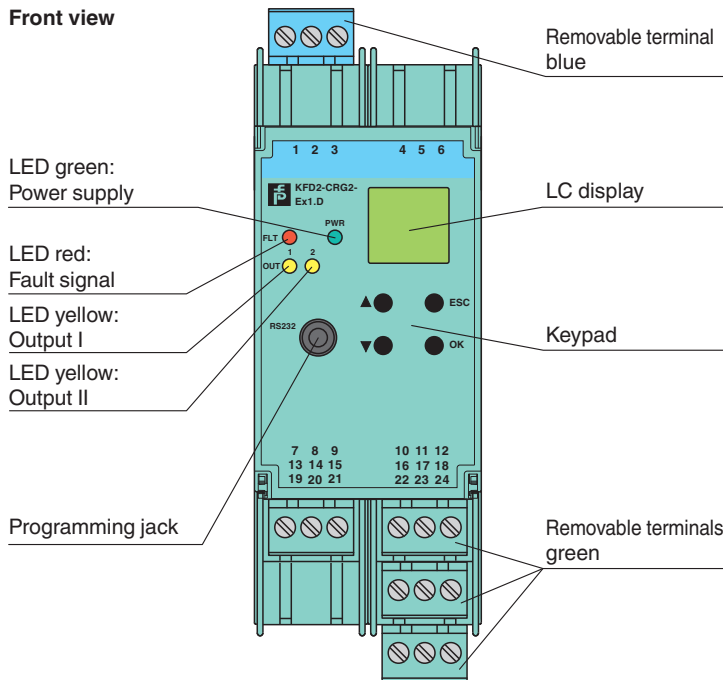



Matching System Components

	DTM Interface Technology	Device type manager (DTM) for interface technology
	PACTware 5.X	FDT Framework
	K-ADP-USB	Programming adapter with USB interface
	KFD2-EB2	Power Feed Module
	UPR-03	Universal Power Rail with end caps and cover, 3 conductors, length: 2 m
	UPR-03-M	Universal Power Rail with end caps and cover, 3 conductors, length: 1,6 m
	UPR-03-S	Universal Power Rail with end caps and cover, 3 conductors, length: 0.8 m





Release date: 2022-02-24 Date of issue: 2022-02-24 Filename: 255620_eng.pdf

Refer to "General Notes Relating to Pepperl+Fuchs Product Information".

Matching System Components

	K-DUCT-BU	Profile rail, wiring comb field side, blue
	K-DUCT-BU-UPR-03	Profile rail with UPR-03- * insert, 3 conductors, wiring comb field side, blue

Accessories

	K-250R	Measuring resistor
	K-500R0%1	Measuring resistor
	KF-ST-5GN	Terminal block for KF modules, 3-pin screw terminal, green
	KF-ST-5BU	Terminal block for KF modules, 3-pin screw terminal, blue
	KF-CP	Red coding pins, packaging unit: 20 x 6

Characteristic Curve

Maximum Switching Power of Output Contacts

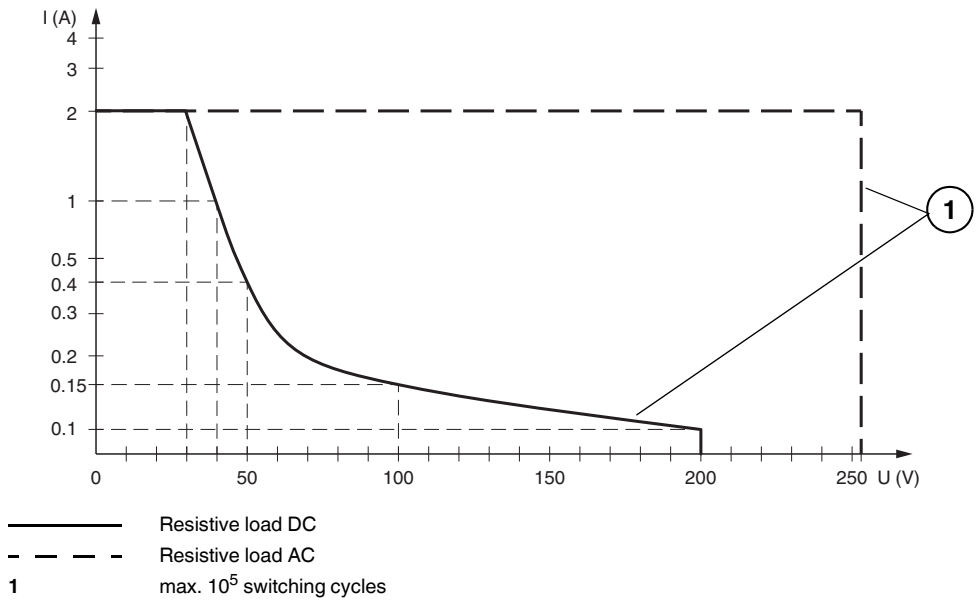

Release date: 2022-02-24 Date of issue: 2022-02-24 Filename: 255620_eng.pdf

Refer to "General Notes Relating to Pepperl+Fuchs Product Information".

Pepperl+Fuchs Group
www.pepperl-fuchs.com

USA: +1 330 486 0002
pa-info@us.pepperl-fuchs.com

Germany: +49 621 776 2222
pa-info@de.pepperl-fuchs.com

Singapore: +65 6779 9091
pa-info@sg.pepperl-fuchs.com

PEPPERL+FUCHS