

# Switch Amplifier

## KCD2-SON-Ex2.R1

- 2-channel isolated barrier
- 24 V DC supply (Power Rail)
- Dry contact or NAMUR inputs
- 2 passive transistor outputs (resistive)
- Application-specific outputs
- Line fault transparency (LFT)
- Housing width 12.5 mm
- SIL 2 (SC 3) acc. to IEC/EN 61508



### Function

This isolated barrier is used for intrinsic safety applications. The device transfers digital signals (NAMUR sensors or dry contacts) from a hazardous area to a safe area. Each input controls a passive transistor output with a resistive output characteristic. The outputs have three defined states: 1-Signal = 6.5 V voltage drop, 0-Signal = 33 kΩ and 6.5 V voltage drop and fault > 100 kΩ. This output characteristic offers line fault transparency on the signal lines. Via switches the mode of operation can be reversed and the line fault detection can be switched off. A fault is signaled by LEDs acc. to NAMUR NE44 and a separate collective error message output.

### Connection

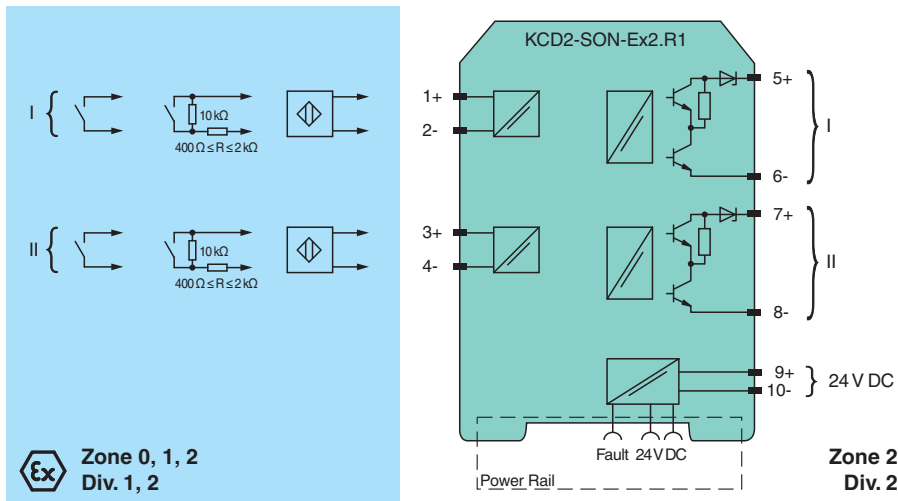

### Technical Data

#### General specifications

Signal type Digital Input

#### Functional safety related parameters

Safety Integrity Level (SIL) SIL 2  
 Systematic capability (SC) SC 3

#### Supply

Connection Power Rail or terminals 9+, 10-  
 Rated voltage  $U_r$  19 ... 30 V DC  
 Ripple  $\leq 10\%$   
 Rated current  $I_r$  35 ... 25 mA

Release date: 2022-01-10 Date of issue: 2022-01-10 Filename: 250096\_eng.pdf

Refer to "General Notes Relating to Pepperl+Fuchs Product Information".

Pepperl+Fuchs Group  
 www.pepperl-fuchs.com

USA: +1 330 486 0002  
 pa-info@us.pepperl-fuchs.com

Germany: +49 621 776 2222  
 pa-info@de.pepperl-fuchs.com

Singapore: +65 6779 9091  
 pa-info@sg.pepperl-fuchs.com

**PEPPERL+FUCHS**

## Technical Data

Power dissipation		≤ 750 mW
<b>Input</b>		
Connection side		field side
Connection		terminals 1+, 2-; 3+, 4-
Rated values		acc. to EN 60947-5-6 (NAMUR)
Open circuit voltage/short-circuit current		approx. 10 V DC / approx. 8 mA
Switching point/switching hysteresis		1.2 ... 2.1 mA / approx. 0.2 mA
Line fault detection		breakage I ≤ 0.1 mA , short-circuit I ≥ 6.5 mA
Pulse/Pause ratio		min. 100 µs / min. 100 µs
<b>Output</b>		
Connection side		control side
Connection		output I: terminals 5, 6 ; output II: terminals 7, 8
Rated voltage	U <sub>r</sub>	19 ... 30 V DC with external resistance > 2 kΩ, e. g. 16-channel ProSafe DI card SDV144 from Yokogawa
Response time		≤ 200 µs
Output I, II		signal or error message, passive transistor output (resistive) 0-signal: 33 kΩ ± 5 % + voltage drop 6.5 V ± 0.5 V 1-signal: voltage drop 6.5 V ± 0.5 V fault: > 100 kΩ
Collective error message		Power Rail
<b>Transfer characteristics</b>		
Switching frequency		≤ 5 kHz
<b>Galvanic isolation</b>		
Input/Output		reinforced insulation acc. to EN 50178, rated insulation voltage 300 V <sub>eff</sub>
Input/power supply		reinforced insulation acc. to EN 50178, rated insulation voltage 300 V <sub>eff</sub>
Output/power supply		basic insulation according to EN 50178, rated insulation voltage 50 V <sub>eff</sub>
Output/Output		basic insulation according to EN 50178, rated insulation voltage 50 V <sub>eff</sub>
<b>Indicators/settings</b>		
Display elements		LEDs
Control elements		DIP switch
Configuration		via DIP switches
Labeling		space for labeling at the front
<b>Directive conformity</b>		
Electromagnetic compatibility		
Directive 2014/30/EU		EN 61326-1:2013 (industrial locations)
<b>Conformity</b>		
Electromagnetic compatibility		NE 21:2011 , EN 61326-3-2:2008
Degree of protection		IEC 60529:2001
Protection against electrical shock		IEC 61010-1:2010
Input		EN 60947-5-6:2000
<b>Ambient conditions</b>		
Ambient temperature		-20 ... 60 °C (-4 ... 140 °F) extended ambient temperature range up to 70 °C (158 °F), refer to manual for necessary mounting conditions
<b>Mechanical specifications</b>		
Degree of protection		IP20
Connection		screw terminals
Mass		approx. 100 g
Dimensions		12.5 x 119 x 114 mm (0.5 x 4.7 x 4.5 inch) (W x H x D) , housing type A2
Mounting		on 35 mm DIN mounting rail acc. to EN 60715:2001
<b>Data for application in connection with hazardous areas</b>		
EU-type examination certificate		BASEEFA 13 ATEX 0080
Marking		⊕ II (1)G [Ex ia Ga] IIC ⊕ II (1)D [Ex ia Da] IIIC ⊕ I (M1) [Ex ia Ma] I
Input		Ex ia

Release date: 2022-01-10 Date of issue: 2022-01-10 Filename: 250096\_eng.pdf

Refer to "General Notes Relating to Pepperl+Fuchs Product Information".

 Pepperl+Fuchs Group  
www.pepperl-fuchs.com

 USA: +1 330 486 0002  
pa-info@us.pepperl-fuchs.com

 Germany: +49 621 776 2222  
pa-info@de.pepperl-fuchs.com

 Singapore: +65 6779 9091  
pa-info@sg.pepperl-fuchs.com

 **PEPPERL+FUCHS**

**Technical Data**

Voltage	U <sub>o</sub>	10.5 V
Current	I <sub>o</sub>	17.1 mA
Power	P <sub>o</sub>	45 mW (linear characteristic)
<b>Supply</b>		
Maximum safe voltage	U <sub>m</sub>	253 V AC (Attention! U <sub>m</sub> is no rated voltage.)
<b>Output</b>		
Maximum safe voltage	U <sub>m</sub>	253 V AC (Attention! The rated voltage can be lower.)
Certificate	CML 19 ATEX 4410 X	
Marking	Ⓜ II 3G Ex ec IIC T4 Gc	
<b>Galvanic isolation</b>		
Input/Output	safe electrical isolation acc. to IEC/EN 60079-11, voltage peak value 375 V	
Input/power supply	safe electrical isolation acc. to IEC/EN 60079-11, voltage peak value 375 V	
<b>Directive conformity</b>		
Directive 2014/34/EU	EN IEC 60079-0:2018 , EN 60079-7:2015+A1:2018 , EN 60079-11:2012	
<b>International approvals</b>		
<b>UL approval</b>		
Control drawing	116-0374 (cULus)	
<b>IECEX approval</b>		
IECEX certificate	IECEX BAS 13.0046 IECEX CML 19.0147X	
IECEX marking	[Ex ia Ga] IIC , [Ex ia Da] IIIC , [Ex ia Ma] I Ex ec IIC T4 Gc	
<b>General information</b>		
Supplementary information	Observe the certificates, declarations of conformity, instruction manuals, and manuals where applicable. For information see <a href="http://www.pepperl-fuchs.com">www.pepperl-fuchs.com</a> .	

**Assembly**

**Front view**

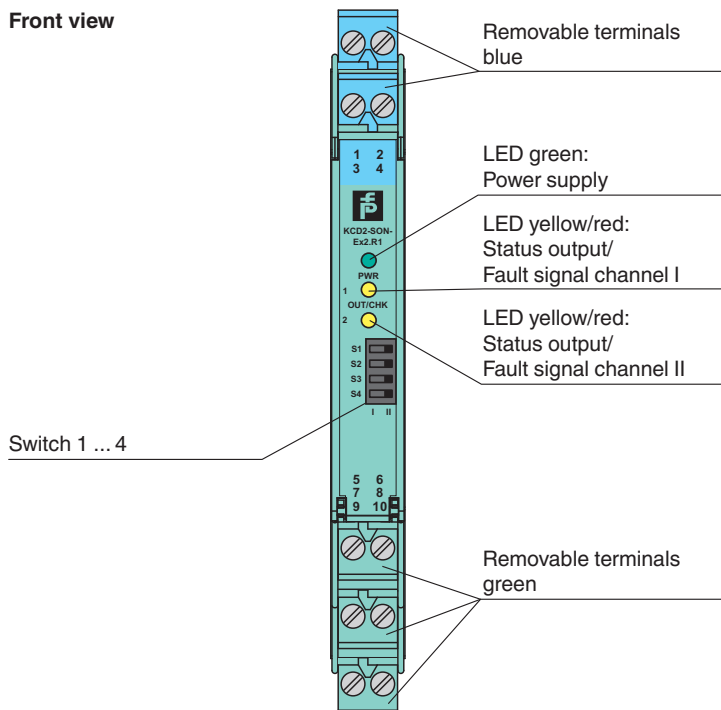





Release date: 2022-01-10 Date of issue: 2022-01-10 Filename: 250096\_eng.pdf

## Matching System Components

	<b>KFD2-EB2</b>	Power Feed Module
	<b>UPR-03</b>	Universal Power Rail with end caps and cover, 3 conductors, length: 2 m
	<b>UPR-03-M</b>	Universal Power Rail with end caps and cover, 3 conductors, length: 1,6 m
	<b>UPR-03-S</b>	Universal Power Rail with end caps and cover, 3 conductors, length: 0.8 m
	<b>K-DUCT-BU</b>	Profile rail, wiring comb field side, blue
	<b>K-DUCT-BU-UPR-03</b>	Profile rail with UPR-03- * insert, 3 conductors, wiring comb field side, blue

## Accessories

	<b>F-NR3-Ex1</b>	NAMUR Resistor Network
	<b>KC-ST-5GN</b>	Terminal block for KC modules, 2-pin screw terminal, green
	<b>KC-ST-5BU</b>	Terminal block for KC modules, 2-pin screw terminal, blue
	<b>KF-CP</b>	Red coding pins, packaging unit: 20 x 6

**Application**

This device is compatible to the control:

- Yokogawa ProSafe DI card SDV144

Compatibility check to other ESD/DCS systems on request.

**Configuration**

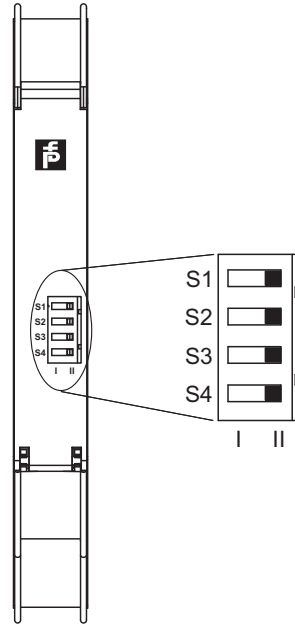

**Switch settings**

S	Function		Position
1	Mode of operation output I (active)	with high input current	I
		with low input current	II
2	Mode of operation output II (active)	with high input current	I
		with low input current	II
3	Line fault detection of the input I	ON	I
		OFF	II
4	Line fault detection of the input II	ON	I
		OFF	II

**Operating states**

Control circuit	Input signal
Initiator high impedance/contact opened	low input current
Initiator low impedance/contact closed	high input current
Lead breakage, lead short circuit	Line fault

Factory setting: switch 1, 2, 3 and 4 in position I

**Characteristic Curve**

**Switching points**

Release date: 2022-01-10 Date of issue: 2022-01-10 Filename: 250096\_eng.pdf

Refer to "General Notes Relating to Pepperl+Fuchs Product Information".

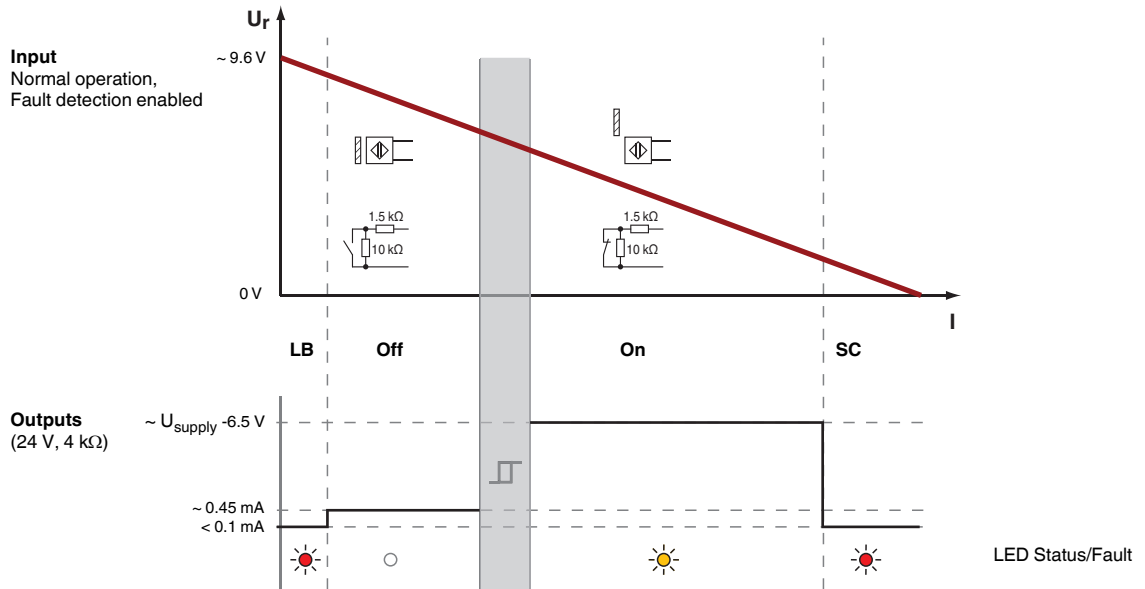

Release date: 2022-01-10 Date of issue: 2022-01-10 Filename: 250096\_eng.pdf